

Data Sheet



Article number: 20028398

Description: E+G
Spring plunger GN 610-3-12-H

Measures

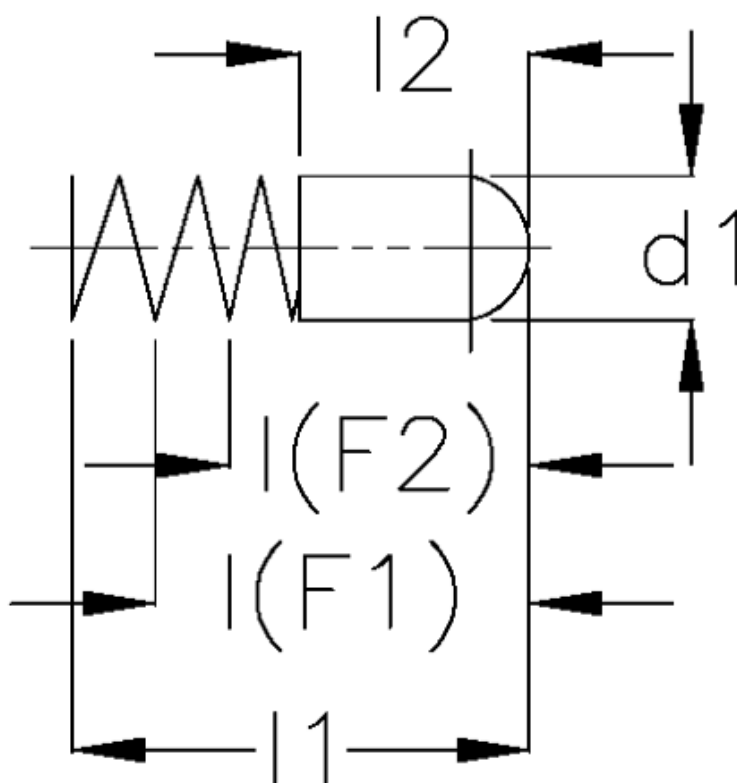

d1	= 3.0
l(F1)	= 9.0
l(F2)	= 8.7
l1	= 12
l2	= 6.0
Spring pressure (F1) N	= 6.2
Spring pressure (F2) N	= 6.8